



**LIFE**

SCIENCE

**SONOCO**  
**THERMOSAFE**<sup>®</sup>



## About ThermoSafe

Sonoco ThermoSafe, a unit of Sonoco, is the leading global provider of temperature assurance packaging for the safe and efficient transport of pharmaceuticals, biologics, vaccines and other temperature sensitive products. Sonoco ThermoSafe shipping solutions mitigate risk for our customers and ensure product efficacy throughout the extremes of a supply chain. With operations in North America, Europe, Asia and South America, the Company has a vast product offering featuring leading technology that encompasses refrigerated, frozen or controlled room temperature applications. In addition, Sonoco ThermoSafe's ISC Labs<sup>®</sup> design and testing services deliver individualized and innovative packaging solutions along with qualification and validation services to meet all regulatory requirements.

## About Sonoco

Founded in 1899, Sonoco is a \$5 billion global manufacturer of industrial and consumer products and provider of packaging services, with more than 300 operations in 35 countries, serving customers in some 85 nations. Sonoco is a proud member of the Dow Jones Sustainability World Index. For more information on the Company, visit our website at [www.sonoco.com](http://www.sonoco.com).

---

**For more information, visit: [www.thermosafe.com](http://www.thermosafe.com)**

North America +1 800 225 7443 | Europe +353 22 55112 | Asia +65 6264 4533



## Temperature Assurance Products

Guide: Selecting the Right Shipper . . . . .	3
Guide: Sizing the Insulated Container . . . . .	4
Insulated Shipper EPS . . . . .	5
Insulated Shipper PUR . . . . .	7
Insulated Shipper VIP . . . . .	9
Guide: Selecting the Right Refrigerant . . . . .	10
<b>WATER-BASED REFRIGERANTS</b>	
PolarPack® Gel Packs . . . . .	11
<b>PHASE CHANGE TECHNOLOGY</b>	
U-tek® Phase Change Materials . . . . .	12
PureTemp™ Phase Change Materials . . . . .	13
<b>READY-ENGINEERED INSULATED SHIPPING SYSTEMS . . . . .</b>	
Envoy® Insulated Shipper . . . . .	15
Certis® Qualified Shipper . . . . .	16
Via™ Insulated Shipper . . . . .	17
Envoy & Certis Series Pallet Shippers . . . . .	18
Medical Transporter . . . . .	19
Storage/Transport Chest . . . . .	21
Envoy® Diagnostic Shipper . . . . .	23
Diagnostic Shipper . . . . .	24
Infectious Shipper . . . . .	27
Lab Mailer . . . . .	28
Packaging Material . . . . .	33
Lab Ware . . . . .	33
ISC Labs® . . . . .	34



# Guide: Selecting the Right Shipper

Sonoco ThermoSafe offers an extensive line of insulated containers for the safe storage and delivery of temperature-sensitive products. Our selection includes various sizes of EPS (Expanded Polystyrene), PUR (Polyurethane), and VIP (Vacuum Insulated Panels) insulated shippers and containers, that are each sold separately (no refrigerants included), as well as various lines of ready-engineered systems— such as Via™, Certis® and Envoy®— that have been designed, tested, and qualified to perform per required criteria. Information regarding insulation properties and other specific characteristics of shippers & containers can be found on corresponding product pages.

When selecting a container and refrigerant to best maintain your product temperature and protect against physical damage during shipment, there are a number of different factors that must be considered. For example:

- Does the product need to remain frozen, refrigerated, or at controlled room temperature?
- How long will it be in transit?
- Is the product of uniform shape or is it irregular?
- What ambient temperatures do you expect?\*

The following guidelines are intended to help you select the best insulated container for shipping your product. We strongly recommend that you use them as the basis for selecting a container and/or refrigerant for testing and evaluation. Sonoco ThermoSafe offers thermal package design, testing, and qualification services through ISC Labs®. For more information, see **page 34** of this catalog or call our Customer Service department at **+1 800 225 7443**.

	EPS			PUR	VIP
Wall Thickness [in.]	¾" - 1 ⅛"	1 ½"	> 1 ½"	1" to 3"	½" - 1"
Benefit Summary	<ul style="list-style-type: none"> <li>• Economical</li> <li>• Lightweight</li> <li>• Recyclable</li> <li>• Excellent dry ice sublimation</li> </ul>			<ul style="list-style-type: none"> <li>• Construction offers great shock absorption and cushioning during shipping &amp; handling</li> <li>• Withstands &gt; 5,000 lbs. crush-compression</li> </ul>	<ul style="list-style-type: none"> <li>• Reduces refrigerant requirements (usage)</li> <li>• Greater net payload utilization</li> <li>• Reduction in shipping weight and freight cost</li> <li>• Environmentally neutral, recyclable</li> </ul>
Transit Duration	< 24 hrs.	< 24 hrs.	≤ 48 hrs.	Ideal for > 48 hrs.	> 96 hrs.
Ideal for	Safe storage & delivery of refrigerated or frozen material [pharmaceuticals, laboratory specimens, serums, vaccines, human organs, culture pack, and nuclear and isotope materials]			<ul style="list-style-type: none"> <li>• Highly temperature-sensitive shipments from moderate to extreme ambient temperature exposure</li> <li>• Heavier and denser payloads</li> </ul>	<ul style="list-style-type: none"> <li>• Extended shipping times and/or distances</li> <li>• Good for international shipments</li> <li>• Pharmaceuticals and vaccines</li> </ul>
Construction	Molded expanded polystyrene			<ul style="list-style-type: none"> <li>• Rigid polyurethane insulation thick walls</li> <li>• Outer corrugate and interior corrugated liner</li> </ul>	<ul style="list-style-type: none"> <li>• 1/2" to 1" Vacuum insulated panels</li> <li>• No EPS or container liner required on outer shell</li> <li>• Outer corrugate</li> </ul>
Components	Shippers sold separately, with or without outer corrugate			<ul style="list-style-type: none"> <li>• Flexible, open cell polyurethane plug [cushions and insulates content]</li> </ul>	N/A

NOTE: \*Ambient temperatures affect package performance.

# Guide: Sizing the Insulated Container – Step by Step

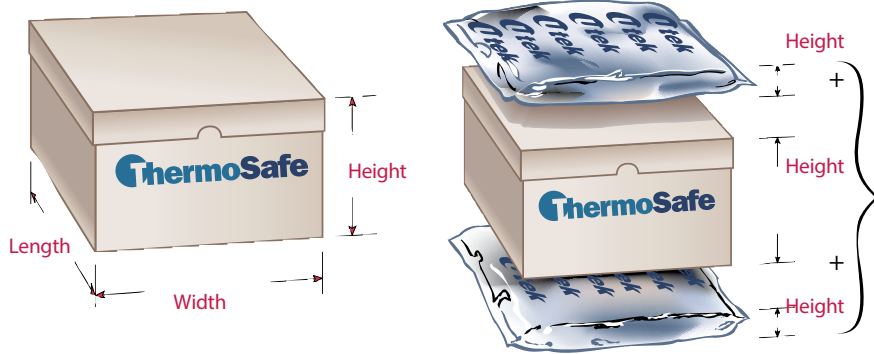

1. Place the product(s) to be shipped as compactly as possible on a flat surface.
2. Measure the product dimensions (length, width, and height).
3. If refrigerant is required, allow sufficient additional space. Depending on the refrigerant that will be used, it may be necessary to allow for space on one or more sides of the product.

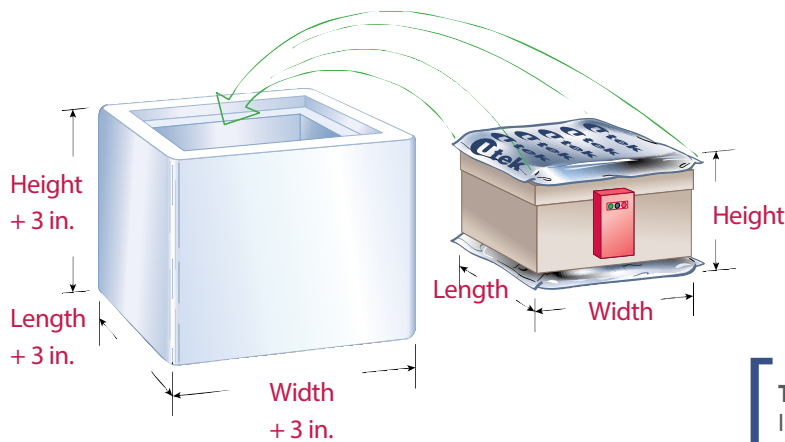

**To calculate outside dimensions:**  
 $\text{Inner Dimensions} + (\text{Wall Thickness} \times 2)$

4. From the inside dimensions column, (see product chart) select the smallest container that will hold your product(s) and any necessary refrigerant. For best results, use a container with at least 1½" thick walls. For short trips or less temperature-sensitive products, containers with ¾"-1" thick walls may be adequate.
5. Place the product(s) and refrigerant in the container.  
  
Use a temperature data logger to monitor the temperature of the shipment while in transit.
6. Before closing the insulated container, fill all empty space with dunnage material to help maximize insulating performance.

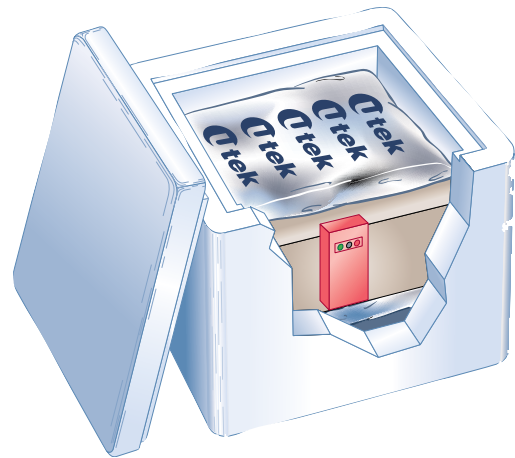

# ThermoSafe® InsulatedShipper



Our extensive line of EPS insulated containers offer the ideal solution for the safe storage and delivery of many refrigerated or frozen materials. This includes pharmaceuticals, laboratory specimens, serums and vaccines, human organs, culture pack, and nuclear and isotope materials.

### Exclusive Modular System

creates a perfect match between payload and container capacity



- Patented components— basic container (body and dome lid), stackable rings —enable you to just add rings for added height
- Increase packing flexibility in warehouse - only one box footprint plus rings to vary capacity as needed
- Design features include dome lids, molded-in handles, rounded corners and edges, and recessed strapping grooves
- Designed to maximize temperature control and withstand the hazards of transport

Construction		EPS/FOAM ONLY		Wall Thickness in.
EPS	EPS in Corrugated Carton	Inner [L x W x H] in.	Outer [L x W x H] in.	
675	676	24 x 18 x 21	26 x 20 x 23	1
637	638	24 x 13 7/8 x 12 1/2	28 3/4 x 17 1/4 x 15 5/8	1 1/2
671	672	23 3/4 x 15 13/16 x 6 5/16	24 7/8 x 17 7/16 x 8 3/8	3/4
831	832	23 3/8 x 14 1/8 x 23	27 7/8 x 19 x 28	2 1/4
627UPS+	628UPS+	23 x 10 x 6	25 x 12 x 8 1/2	1
623UPS+	624UPS+	23 x 10 x 4	25 x 12 x 6 1/2	1
668	669	21 9/16 x 13 7/16 x 10 5/8	24 x 15 7/8 x 12 3/8	1 1/8
498	499	21 x 15 1/8 x 15 1/4	24 x 18 x 17 7/8	1 1/8
421	423	19 3/8 x 11 1/4 x 3 7/8	22 5/8 x 14 7/8 x 7 1/4	1 1/2
483	484	19 3/8 x 9 x 10 3/8	22 7/8 x 13 3/8 x 13 3/8	1 1/2
803	804	19 1/4 x 12 3/8 x 12 1/4	23 5/8 x 16 3/4 x 16 1/2	2
481	482	19 x 14 5/8 x 10 3/8	22 3/8 x 18 1/8 x 13 3/8	1 1/2
397*	398*	19 3/8 x 12 3/8 x 12 1/4	22 3/8 x 15 3/8 x 15 3/8	1 1/2
397R-2		2" RING		1 1/2
397R-3		3" RING		1 1/2
431UPS	433	17 1/4 x 10 1/4 x 8	20 1/4 x 13 3/8 x 11	1 1/2
806*	851*	17 1/4 x 10 1/4 x 5	20 1/4 x 13 1/4 x 8"	1 1/2
806R3		3" RING		1 1/2
801	802	17 1/4 x 10 x 12 3/4	21 1/16 x 14 7/16 x 16 3/4	2
428	430	17 1/8 x 10 1/8 x 10 5/8	20 1/4 x 13 1/4 x 13 3/4	1 1/2
809*	812*	17 x 17 x 12	21 1/16 x 21 7/16 x 16 3/4	2
809R3		3" RING		3
673	674	17 x 11 3/4 x 8	18 5/8 x 13 3/8 x 9 5/8	3/4
351	352	17 x 9 7/8 x 16 1/2	20 3/8 x 13 1/4 x 19 1/2	1 1/2
655	656	16 3/4 x 13 3/4 x 12 5/8	19 1/2 x 16 1/2 x 15 1/8	1 1/2
493	494	16 3/4 x 9 3/4 x 12 5/8	20 1/4 x 13 1/4 x 15 3/4	1 1/2
634	635UPS	16 1/8 x 11 1/2 x 6"	19 1/4 x 14 1/2 x 9	1 1/2
657	658	15 13/16 x 12 13/16 x 8 1/2	18 1/8 x 15 1/8 x 10 7/8	1
665	666	15 3/8 x 9 5/8 x 7 7/16	17 x 11 1/4 x 9	3/4
631	632	14 x 10 5/8 x 6	18 x 13 3/8 x 9	1 1/2
663	664	13 3/4 x 11 x 6 3/4	16 1/2 x 13 3/4 x 8 3/4	1 1/8
686	687	13 3/8 x 9 5/8 x 5 1/8	16 x 12 1/8 x 7 3/4	1
682	683	13 1/2 x 13 x 10 1/2	17 1/2 x 16 1/2 x 13 1/2	1 3/4
807*	871*	13 1/4 x 6 1/4 x 1 7/8	16 1/4 x 9 1/4 x 4 7/8	1 1/2
807R3		3" RING		3

+ Top and bottom are approximately equal halves, not body and lid construction.

\* Dome style lid .

- Choose EPS only or EPS assembled in 200 lb [91 kg] test corrugated carton
- Choose insulating walls of 3/4 to 2 1/4 in. [19 to 57 mm]

### Lid Styles

The images below show the difference between a plug-style and dome-style lid. The model numbers with the \* next to them in the table to the right are those that are molded with a dome-style lid.

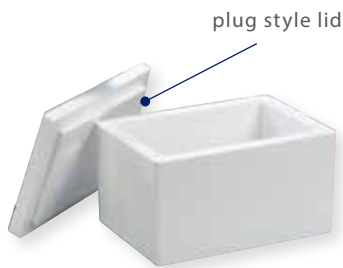

Construction		EPS/FOAM ONLY		Wall Thickness in.
EPS	EPS in Corrugated Carton	Inner [L x W x H] in.	Outer [L x W x H] in.	
477	479	13 1/8 x 9 1/4 x 6	15 1/2 x 11 1/2 x 8	1
614	615	12 1/2 x 12 1/2 x 12	15 1/2 x 15 1/2 x 15	1 1/2
612	613	12 1/2 x 12 1/2 x 9	15 1/2 x 15 1/2 x 12	1 1/2
610	611	12 1/2 x 12 1/2 x 7	15 1/2 x 15 1/2 x 10	1 1/2
808*	814*	12 1/2 x 12 1/2 x 6	15 1/2 x 15 1/2 x 9	1 1/2
808R3		3" RING		1 1/2
491UPS+	492UPS+	12 1/4 x 8 1/2 x 5 1/4	15 1/2 x 11 3/4 x 8 1/4	1 1/2
452	453	12 x 12 x 11 1/2	16 x 16 x 15 1/2	2
661	662	12 x 12 x 9 3/4	15 1/4 x 14 x 11 1/2	1 3/8
348UPS	326	11 5/8 x 9 7/8 x 9	15 x 13 3/4 x 12	1 1/2
333	325UPS	11 5/8 x 9 7/8 x 7	14 7/8 x 13 1/4 x 10 1/8	1 1/2
489UPS	490UPS	11 3/4 x 10 x 5	15 x 13 1/4 x 9 1/16	1 1/2
489UPSR-2		2" RING		1 1/2
328UPS	346UPS	11 3/8 x 8 3/8 x 11	13 3/4 x 10 1/2 x 13	1
425	355	11 x 11 x 11 5/8	14 x 14 x 14 5/8	1 1/2
688	689	10 3/4 x 6 3/4 x 5 1/2	12 13/16 x 9 9/8 x 8	1
684	685	10 1/2 x 8 x 8 1/2	14 x 11 1/2 x 12	1 3/4
315UPS	317UPS	10 1/2 x 7 1/4 x 10	13 3/4 x 10 1/2 x 13 1/2	1 1/2
446UPS	448UPS	10 x 10 x 7	14 x 14 x 10	1 3/4
653	654	9 1/2 x 7 1/2 x 10 3/8	11 x 9 x 12	3/4
651	652	9 1/2 x 7 1/2 x 8 3/8	11 x 9 x 10	3/4
648	649	9 1/2 x 7 1/2 x 5 5/8	11 x 9 x 7	3/4
621UPS+	622UPS+	9 3/8 x 8 1/8 x 8 1/8	12 1/2 x 11 1/4 x 11 1/8	1 1/2
618UPS+	619UPS+	9 3/8 x 8 1/8 x 6 3/8	12 1/2 x 11 1/4 x 9 1/2	1 1/2
616UPS+	617UPS*	9 1/2 x 8 1/4 x 4 5/8	12 x 11 1/4 x 7 7/8	1 1/2
322UPS	324UPS	8 x 5 7/8 x 11 1/2	11 x 9 x 14 1/2	1 1/2
319*	321UPS*	8 x 5 7/8 x 8 7/8	11 x 9 x 11 7/8	1 1/2
411*	413*	8 x 5 7/8 x 7	11 x 9 x 10	1 1/2
316*	318*	8 x 6 x 4 1/4	11 x 9 x 7 1/4	1 1/2
316R2		2" RING		1 1/2
680	681	7 x 7 1/4 x 7 1/2	11 3/4 x 11 3/4 x 11 1/4	2
438	439	6 1/4 x 5 3/4 x 7 3/4	11 1/4 x 10 1/2 x 12 5/8	2 1/4
457	312	6 1/2 dia. x 4 high	9 1/2 x 9 1/2 x 6 7/8	1 1/2
608UPS	609UPS	6 1/4 x 4 1/4 x 5 1/2	9 x 7 1/2 x 8	1 1/2
445	447UPS	6 1/4 x 4 1/4 x 5 1/2	11 x 9 x 10 1/4	2 1/4
646	647	6 x 4 1/2 x 2 1/2	8 x 6 1/2 x 4 1/2	1
440+	N/A	5 7/8 x 4 3/8 x 3	8 x 6 x 5 1/4	1
N/A	313	4 1/2 dia. x 7 1/2 high	7 1/4 x 7 1/4 x 9	1 1/2



# ThermoSafe®

## InsulatedShipper-PUR

These high performance polyurethane containers meet the needs of the most demanding temperature-sensitive payloads. Polyurethane insulation offers greater insulating capability when compared to same size EPS containers.

Thick walls and 200 lb [91 kg] outer corrugate offer protective shock absorption and cushioning during shipping and handling.

- Protects highly temperature-sensitive shipments from mild to extreme ambient temperature exposure
- Provides extensive protection for long range journeys
- Complies with international clean air regulations and is CFC and HCFC-free
- Withstands crush compression in excess of 5,000 lbs [2 tons]
- Includes flexible polyurethane foam plug seals the top, cushions and insulates contents, and vents dry ice

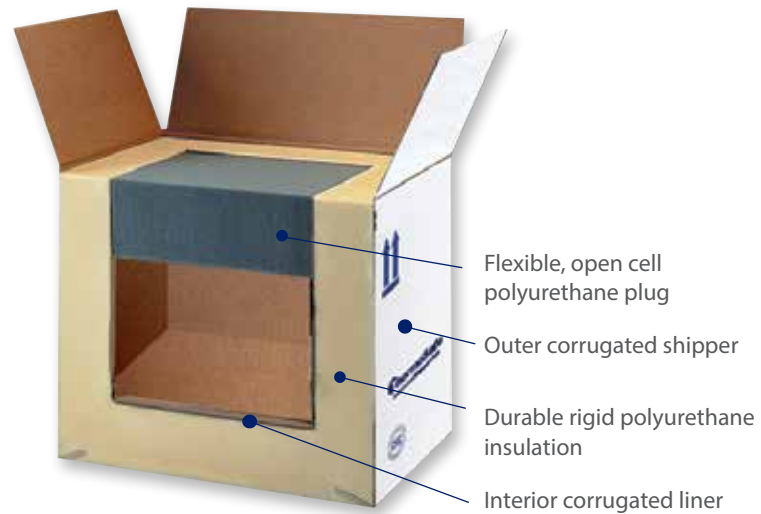

Rigid, one-piece, three-layer laminate construction provides excellent temperature protection, exceptional strength and durability.





Model	Dimensions L x W x H		Wall Thickness [in.]	Empty Weight [lbs]
	Inner [in.]	Outer [in.]		
E731	30½ x 21¼ x 19⅝	37⅜ x 28 x 24¼	3	26
E168	23¼ x 9¼ x 13½	28 x 14 x 20¾	2	9½
E438	22¼ x 17½ x 19⅝	29 x 24¼ x 24¼	3	17½
E238	19 x 15¾ x 13¾	22¾ x 19½ x 19½	1½	9
E337	18½ x 18¼ x 16¾	25¼ x 25 x 24¾	3	17½
E327	18½ x 18¼ x 16¾	23¼ x 23 x 24	2	14
E186	18½ x 14½ x 12	23¼ x 19¼ x 19¼	2	10
E137	17½ x 9½ x 14½	24¼ x 16¼ x 21⅝	3	12
E145	17¼ x 9½ x 15¼	22 x 14¼ x 22½	2	9
E200	16 x 16 x 13½	19¾ x 19¾ x 19¾	1½	8
E89	16¼ x 9¼ x 10¼	21 x 14 x 17½	2	7½
E104	15¼ x 10¾ x 11	18 x 13½ x 15¼	1	4½
E124	15 x 13 x 11	18¾ x 16¾ x 16¾	1½	6½
E126	14¼ x 10 x 15¼	19 x 14¾ x 22½	2	8
E65	14 x 8 x 10	18¾ x 12¾ x 17¼	2	6
E174	13½ x 13½ x 16½	20¼ x 20¼ x 24½	3	14½
E69	12¼ x 12¼ x 8	15 x 15 x 12¼	1	4
E90	12 x 10 x 13	18¾ x 16¾ x 21¼	3	10½
E221	11½ x 11½ x 32⅞	18¾ x 18¾ x 36⅞	3	16
E38	11 x 8½ x 7	17¾ x 15¼ x 15¼	3	7
E36	11 x 8 x 7	15¾ x 12¾ x 14¼	2	4
E21	10¾ x 7 x 5	13⅝ x 9⅞ x 9¼	1	2
E46	10 x 10 x 8	12¾ x 12¾ x 12¼	1	3
E28	9¼ x 7 x 7¼	13 x 10¾ x 13	1½	3
E50	8 x 7⅞ x 15	14¾ x 13⅞ x 23¼	3	9
E22	8 x 6 x 8	14¾ x 12¾ x 16¼	3	5½
E15	5¼ x 5¼ x 10⅝	10 x 10 x 17⅞	2	3
E9	4½ x 4½ x 8	9½ x 9⅝ x 14⅝	2	2½



# ThermoSafe®

## InsulatedShipper-VIP

These high performance insulated shippers are the best choice for longer duration shipments of high value, temperature sensitive products into global markets.

Our Vacuum Insulated Panel (VIP) Shippers have a tough, non-metalized barrier and outer structural film – yielding a robust shipping container with thermal performance that far surpasses conventional foam boxes.

VIP panels don't require an EPS protective outer shell or container liner due to the durable outer film, allowing smaller container sizes and reducing shipping weight of your package.

Outer structural film provides tight panel fit and provides abrasion protection for a reliable, reusable shipping system.

### Improved thermal performance:

- Reduces gel refrigerant/dry ice requirements
- Reduces overall package size
- Extends shipping duration
- Environmentally neutral and recyclable – no CFC's or HCFC's



Model	Capacity	Dimensions L x W x H		Wall Thickness
		Inner	Outer	
550VIP	5.50 cu. ft.	24" x 22" x 18"	26" x 24" x 20"	1"
200VIP	2.00 cu. ft.	18" x 16" x 12"	20" x 18" x 14"	1"
69VIP	0.69 cu. ft.	12" x 10" x 10"	14" x 12" x 12"	1"
37VIP	0.37 cu. ft.	10" x 8" x 8"	12" x 10" x 10"	1"
76VIP	0.76 cu. ft.	11" x 10" x 12"	12" x 11" x 13"	1/2"
42VIP	0.42 cu. ft.	9" x 8" x 6"	10" x 9" x 11"	1/2"
25VIP	0.25 cu. ft.	9" x 8" x 6"	10" x 9" x 7"	1/2"
07VIP	0.07 cu. ft.	6" x 5" x 4"	7" x 6" x 5"	1/2"

# Guide: Selecting the Right Refrigerant



ThermoSafe offers a wide selection of refrigerants for use with its insulated containers.

This table is intended to assist you with selecting the best refrigerant for your shipments.

Contact Customer Service for pre-conditioned product options and pricing.

Refrigerant	Temperature	Recommended Use	Other Considerations
Dry Ice	-78°C (-109°F)	Products which must be kept frozen for extended periods of time	Should not be used for products which may be damaged by extreme cold. Dry ice is regulated as a hazardous material in air transport
-23°C (-10°F)	-23°C (-10°F)	Products which must be kept frozen	To freeze, freezer must go below -23°C. Provides more lasting protection than standard gel packs
-1°C (+30°F)	-1°C (+30°F)	Products which must be kept cold for long periods of time	Maintains temperatures longer than standard gel packs
Standard Gel	0°C (+32°F)	Most cost-effective alternative to wet ice	Call for pricing and availability information regarding custom printing and returnable tote programs
Moisture Guard	0°C (+32°F)	Products which must be protected from condensation damage	Multi-layer exterior minimizes surface condensation
Foam Brick	0°C (+32°F)	Maintains its shape when frozen or thawed	Vacuum sealed semi-rigid foam block offers consistent weight and shape
Rigid Bottle	0°C (+32°F)	Offers maximum durability while maintaining package configuration	Our most rugged refrigerant
Advanced Phase Change Materials	-40°C to +37°C		



# PolarPack®

PolarPack refrigerants provide thermal solutions for temperature critical packages during transit. Available in a broad selection of styles and a multitude of sizes, they are designed to provide reliable temperature protection for a vast array of products and packages.

Contact Customer Service for options and pricing on pre-conditioned product.



## Standard 0°C (+32°F)

An economical alternative to wet ice, enclosed in durable 100µ [4.1 mil] polyethylene film. PolarPack gel packs provide reliable refrigeration for the safe transport of temperature-sensitive products.

	Model	Weight [oz]	Dimensions L x W x H [in.]
	Standard Polar Pack	PP3	3
PP6		6	5 ½ x 3 ½ x ¾
PP8		8	6 ½ x 3 ½ x ¾
PP12		12	6 x 5 ½ x 1
PP16		16	6 ½ x 5 ½ x 1
PP24		24	8 x 5 ½ x 1 ¼
PP32		32	10 ½ x 5 ½ x 1 ¼
PP48		48	10 ½ x 7 ½ x 1 ¼



## Rigid Bottle 0°C (+32°F)

Blow-molded rigid plastic bottles. Our most durable packs are multi-purposed and designed to withstand rugged warehouse packing environments.

Rigid Bottle	HPP16	16	7 x 3 ½ x 1 ½
	HPP32	32	8 x 5 x 1 ¾



## Foam Brick 0°C (+32°F)

These semi-rigid foam bricks never change shape during freezing, thawing or transit. Each brick is vacuum-sealed for consistent weight and shape, enabling superior surface contact for more consistent temperature control.

Foam Brick	FPP7B	7.5	4 ½ x 4 x ¾
	FPP15	15	4 ½ x 4 x 1 ½
	FPP18	18	8 ¼ x 5 ½ x ¾
	FPP23	23	5 x 5 x 1 ¾
	FPP24	24	6 ½ x 4 ½ x 1 ½
	FPP31	31	9 x 4 x 1 ½
	FPP56	56	11 ¼ x 9 ¼ x 1
FPP64	64	10 ½ x 6 ½ x 1 ¾	



## Moisture Guard 0°C (+32°F)

Multi-layered exterior minimizes surface condensation, which protects product from moisture damage.

Moisture Guard	MG8	8	6 x 4 ¾ x ¾
	MG12	12	6 x 5 ½ x ¾
	MG16	16	6 ½ x 5 ½ x ¾
	MG24	24	8 x 5 ½ x 1 ¼
	MG32	32	10 ½ x 5 ½ x 1 ¼
	MG48	48	10 ½ x 7 ½ x 1 ¼

# U-tek®



Superior protection for shipping temperature-sensitive materials. Maintains critical temperatures of serums, test samples, live or frozen tissues, organs, and pharmaceuticals for extended periods. Laminated, metallized film exterior provides radiant heat barrier and resists punctures.

Model	Formula	Weight [oz]	Dimensions [in.] LxWxH
429	-1°C (+30°F)	8	6 x 4 x 3/4
412	-1°C (+30°F)	12	6 3/4 x 4 x 1
596	-1°C (+30°F)	16	6 1/2 x 6 1/2 x 7/8
414	-1°C (+30°F)	24	7 1/2 x 6 1/2 x 1
598	-1°C (+30°F)	32	9 3/8 x 7 3/4 x 1
426	-1°C (+30°F)	48	10 1/2 x 7 3/4 x 1 3/16
432	-23°C (-10°F)	8	6 x 4 x 3/4
418	-23°C (-10°F)	12	6 3/4 x 4 x 1
597	-23°C (-10°F)	16	6 1/2 x 6 1/2 x 7/8
420	-23°C (-10°F)	24	7 1/2 x 6 1/2 x 1
599	-23°C (-10°F)	32	9 3/8 x 7 3/4 x 1
427	-23°C (-10°F)	48	10 1/2 x 7 3/4 x 1 3/16

# U-tek®

**-1°C/+30°F-Mat**

**-1°C/+30°F-Single**

Cushions fragile shipments, and won't dilute ice baths or damage samples. Remains frozen longer than regular ice, without the melting mess.

- May be refrozen and reused, withstands pressures in excess of 60 lb per square inch for five minutes or longer
- Refrigerant contains neutral pH distilled and deionized water, and proprietary materials certified by the U.S. Food and Drug Administration as food grade chemicals

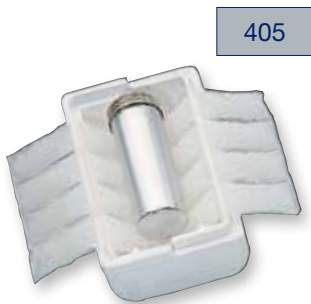

405



405SQ



406J

Model	Style	Description	Dimensions [in.]	Case Weight [lb]
405	Mat	1 roll	16 W x 34 ft L	50
405SQ	Square Mat	28 sheets	16 W x 14 3/4 ft L	50
406J	Singles	Approximately 1500 packets		50



## Innovative Phase Change Material

PureTemp™ Phase Change Materials liquefy or solidify at precise temperatures. When the surrounding temperature falls below the phase temperature, they solidify and release their stored energy. If the temperature rises above the phase temperature, they liquefy and absorb excess energy.

These two phenomena protect the product from excessive heat and cold to help maintain product temperature for extended periods of time. PureTemp is engineered to react to a precise temperature, from -40° to +37°C, and to operate in a very narrow temperature range. It is also renewable, biodegradable, and non-toxic.

PureTemp comes in foam bricks and hard bottles.

### SUSTAINABILITY

- Non-Hazardous, 100% environmentally friendly
- USDA BioPreferred® designation
- Reduces shipping weight, freight, warehouse space, and packout space

### TIGHTER TEMPERATURE CONTROL

- Extensive range of temperature options
- Constant temperature during freezing or melting provides constant temperature control
- Eliminates thermal shock with fewer excursions

### TOTAL COST CONTROL

- Increases payload efficiency
- Reduces shipping weight and freight costs. Less PureTemp material is required for temperature control when compared to water-based refrigerants
- Simplifies packout inventory and process
- Decreases box size for less warehouse and packout space
- Eliminates equilibration time
- Increases shipping duration

### Phase Change Materials vs. Petroleum/Paraffin-Based PCMs

	PureTemp	Petroleum/Paraffin
Latent Heat	210 joules/gram	170 joules/gram
Renewable	Yes	No
Biofriendly	Yes	No
Farmer-Friendly	Yes	No
Cost per Unit	Low	Medium-High
Flammability	Low	High
Degradability	6 months	Non-biodegradable
Rancidity	None	None
Thermal Life Cycle	Limitless	Limitless
Toxicity	Non-toxic	Potentially
Microencapsulation	Yes	Yes



PureTemp™ is manufactured by Entropy Solutions, Inc.



# Ready-Engineered Insulated Shipping Systems



Shipper	Envoy®	Certis®	Via™
Benefit Summary	<ul style="list-style-type: none"> <li>Design-tested per ISCSilver™ Ambient Profile for moderate or partially temperature-controlled distribution conditions</li> <li>Simple and Economical</li> </ul>	<ul style="list-style-type: none"> <li>Pre-Qualified: Choice of two different ambient profiles.                             <ol style="list-style-type: none"> <li>ISCGold™ Ambient Profile for most rigorous ambient conditions</li> <li>ISCSilver™ Ambient Profile for moderate or partially temperature-controlled distribution conditions</li> </ol> </li> </ul>	<ul style="list-style-type: none"> <li>Pre-Qualified</li> <li>Reusable solutions with single use flexibility</li> <li>Robust thermal performance</li> <li>Phase Change Materials (PCM) are organic based and use biodegradable materials</li> </ul>
Transit Duration	1-2 Days	1-5 Days	1-5 Days
Construction	EPS	EPS, PUR, or VIP	VIP



# Envoy<sup>®</sup>

## A Simple and Economical Solution

As the global leader in temperature assurance packaging, Sonoco ThermoSafe is recognized for its expertise and advanced solutions. We also realize that our customers require solutions tailored to address the needs of a wide range of shipping conditions.

For that reason, we've applied our engineering expertise to create Envoy Insulated Shippers—a simple, economical solution for less complex shipping needs, design-tested by ISC Labs.

Envoy is designed to the ISCSilver™ ambient temperature profile, which reflects more moderate shipping conditions.

### Envoy Ready Engineered Shippers Feature:

- A simple solution ideal for 1-2 day shipments and small payloads
- Seasonal packouts that are simple to follow and use foam bricks that maintain their shape for easy assembly
- 2-8° C temperature protection
- Standard components
- An economical option from Sonoco ThermoSafe
- Fast delivery from stock

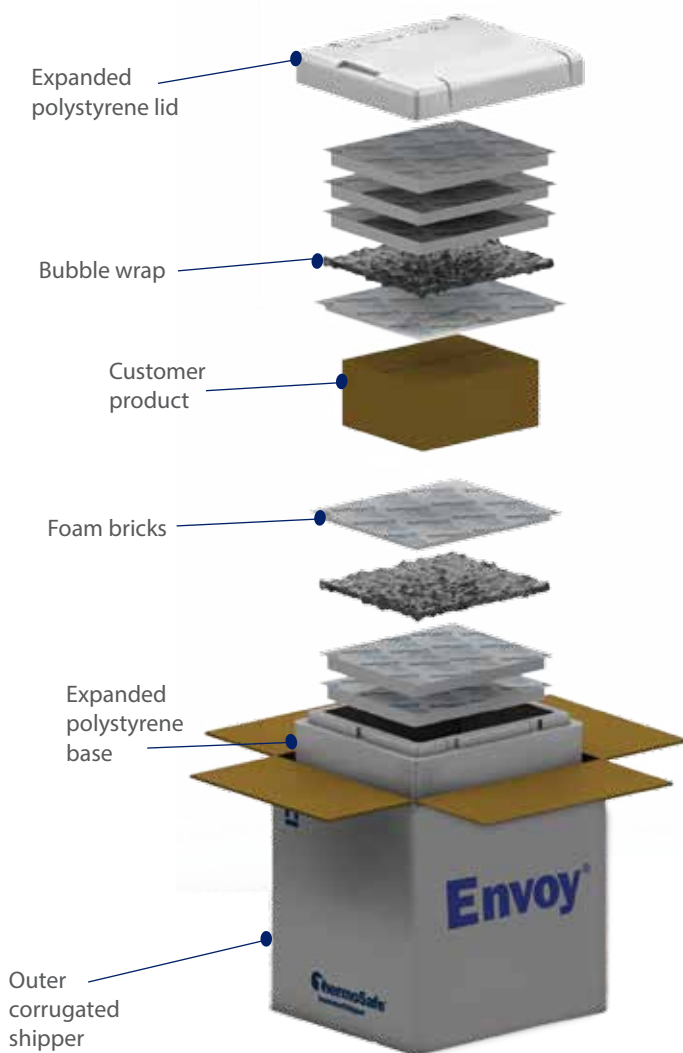

		Small 1-Day	Large 1-Day	Small 2-Day	Large 2-Day
Model Number	Summer	ERSS1SE	ERSS1LE	ERSS2SE	ERSS2LE
	Winter	ERWS1SE	ERWS1LE	ERWS2SE	ERWS2LE
Shipping Duration		30 Hours		54 Hours	
Payload Capacity		2 L	6 L	4 L	7L
Payload Dimensions in. [mm]		7" x 5" x 3" [178 x 127 x 76]	10.5" x 8.75" x 4" [267 x 222 x 102]	10.5" x 8.75" x 2.5" [267 x 222 x 63]	10.5" x 8.75" x 4.5" [267 x 222 x 114]
Container Outer Dimensions in. [mm]		11" x 9" x 14.5" [279 x 229 x 368]	15" x 13.25" x 12" [381 x 337 x 305]	15" x 13.25" x 14" [381 x 337 x 356]	15" x 13.25" x 16" [381 x 337 x 406]
Weight		8 lb [ 4kg ]	11lb [ 5kg ]	22 lb [ 10kg ]	22 lb [ 10kg ]

# Certis®

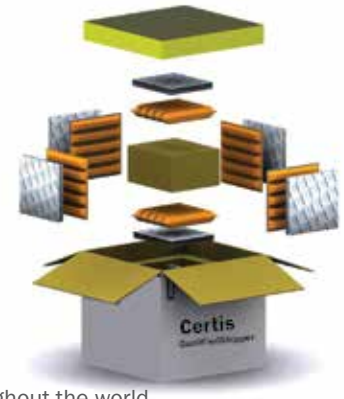

ThermoSafe Certis Qualified Shippers deliver the ultimate protection for your temperature-sensitive pharmaceuticals and biological specimens, and meet the toughest ambient profiles of any premium shipper in the industry. So you can rest easy, knowing that your products will ship safely anywhere in the world.

- Extended shipping durations allow for temperature-sensitive products to be shipped anywhere throughout the world
- Simple and easy-to-follow packing steps
- High payload efficiencies result in reduced shipping weights, freight costs, and tight temperature control

	Certis Gold				Certis Silver			Certis Silver Universal				
	XS	S	M	L	S	M	L	L	L	M	L	XL
Temperature Range	2° to 8° C				2° to 8° C			-20° C	2° to 8° C		15° to 25° C	
Shipping Duration (Hours)	78	78	78	126	30-54	30-54	54-78	72	54	96	72	78
Payload Capacity cu in. [L]	292 [4.8]	472 [7.7]	756 [12.4]	1,196 [19.6]	296 [4.9]	428 [7.0]	882 [14.5]	897 [14.7]	898 [14.7]	720 [11.8]	879 [14.4]	2,135 [35.0]
Packout	Universal				Summer & Winter			Universal				

TEMPERATURE RANGES AVAILABLE	Model	Packout	Insulation	Duration [Hrs]	Container O.D. in. [mm]			Payload Dim in. [mm]			Weight lb [kg]	Dim Wt. lb [kg]
					L	W	H	L	W	H		
2-8°C	CRUG3XP	Universal	PUR	78	21.25 [540]	21.25 [540]	19 [483]	8.5 [216]	6.25 [159]	5.5 [140]	40 [18]	37 [17]
	CRUG3SP	Universal	PUR	78	23.75 [603]	23.75 [603]	19.5 [495]	10.5 [267]	9 [229]	5 [127]	50 [23]	48 [22]
	CRUG3MP	Universal	PUR	78	27.75 [705]	23 [584]	21.25 [540]	10.5 [267]	9 [229]	8 [203]	55 [25]	60 [27]
	CRUG5LV	Universal	VIP	126	24.75 [629]	18.75 [476]	21 [533]	14.5 [369]	8.25 [210]	10 [254]	80 [36]	45 [20]
	CRUS2XE	Universal	EPS	54	21.25 [540]	21.25 [540]	20.75 [527]	9.25 [235]	9.25 [235]	10.5 [267]	36 [16.3]	56 [124]
	CRSS1ZE	Summer	EPS	30	22.25 [565]	17.5 [445]	16 [406]	10.5 [267]	5.25 [133]	5.375 [137]	15.7 [7.1]	38 [83]
	CRWS1ZE	Winter										
	CRSS1WE	Summer	EPS	30	21.75 [552]	17.75 [451]	17.5 [445]	10 [254]	6 [152]	7.125 [181]	19.1 [8.7]	41 [90]
	CRWS1WE	Winter										
	CRSS2ZE	Summer	EPS	54	22.25 [565]	17.5 [445]	16 [406]	10.5 [267]	5.25 [133]	5.375 [137]	21.3 [9.7]	38 [83]
	CRWS2ZE	Winter										
	CRSS2WE	Summer	EPS	54	21.75 [552]	17.75 [451]	17.5 [445]	10 [254]	6 [152]	7.125 [181]	22.2 [10.1]	41 [90]
	CRWS2WE	Winter										
	CRSS2SE	Summer	EPS	54	23.75 [603]	23.75 [603]	19.5 [495]	10.5 [267]	10.5 [267]	8 [203]	39.5 [17.9]	66 [146]
	CRWS2SE	Winter										
	CRSS3SE	Summer	EPS	78	23.75 [603]	23.75 [603]	19.5 [495]	10.5 [267]	10.5 [267]	8 [203]	59.1 [26.8]	66 [146]
CRWS3SE	Winter											
15-25°C	CCUS3XE	Universal	EPS	72	21.25 [540]	21.25 [540]	20.75 [527]	8.75 [222]	8.75 [222]	11.00 [279]	39 [18]	56 [31]
	CCUS4XE	Universal	EPS	96	21.25 [540]	21.25 [540]	20.75 [527]	8.50 [216]	8.50 [216]	10.00 [254]	42 [19]	56 [31]
	CCUS3LP	Universal	PUR	78	33.00 [838]	24.00 [610]	21.00 [533]	20.25 [514]	11.25 [286]	9.38 [238]	90 [41]	100 [55]
<-20°C	CDUS3XE	Universal	EPS	72	21.25 [540]	21.25 [540]	20.75 [527]	9.25 [235]	9.25 [235]	10.50 [267]	41 [19]	56 [31]



## Ideal for clinical trial shipments or other high value payloads

Available in reusable and single-use models or purchase PCMs separately to interchange configurations

Via Pre-Qualified Insulated Shippers have been designed to utilize simple packaging configurations, reduce operational complexity, and optimize total cost of ownership. Ensure the efficacy of your valuable temperature sensitive products and maintain regulatory compliance throughout distribution with Via.



	Part Number	Payload (liters)	Min. Duration	Weight lbs. [kg.]	Payload ID in. [mm.]			Shipper OD in. [mm.]		
					L	W	H	L	W	H
Single Use 2-8°C	37VSRU3V	3.2	3 Day	14.4	7.56	7.19	3.63	12.75	10.75	11.00
				[6.5]	[192]	[183]	[92]	[324]	[273]	[279]
	69VSRU5V	5.2	5 Day	27.8	9.56	9.19	3.63	14.75	12.75	13.00
				[12.6]	[243]	[233]	[92]	[375]	[324]	[330]
Single Use 2-8°C	83VSRU4V	9.9	4 Day	27.3	9.63	9.63	6.50	14.75	12.75	15.00
				[12.4]	[245]	[245]	[165]	[375]	[324]	[381]
Reusable 2-8°C	42VRRU1V	3.2	1 Day	13.6	7.56	7.19	3.63	10.69	9.69	11.94
				[6.2]	[192]	[183]	[92]	[272]	[246]	[303]
	37VRRU3V	3.2	3 Day	16.2	7.56	7.19	3.63	12.75	10.75	11.00
				[7.4]	[192]	[183]	[92]	[324]	[273]	[279]
	69VRRU4V	5.2	4 Day	30.6	9.56	9.19	3.63	14.75	12.75	13.00
				[13.9]	[243]	[233]	[92]	[375]	[324]	[330]
Reusable 2-8°C	83VRRU3V	9.9	3 Day	29.4	9.63	9.63	6.50	14.75	12.75	15.00
				[13.3]	[245]	[245]	[165]	[375]	[324]	[381]
Reusable 2-8°C	83VRRU2V	11.5	2 Day	27.6	9.63	9.63	7.50	14.75	12.75	15.00
				[12.5]	[245]	[245]	[191]	[375]	[324]	[381]
Reusable 20-25°C	42VRCU2V	3.2	2 Day	13.6	7.56	7.19	3.63	10.69	9.69	11.94
				[6.2]	[192]	[183]	[92]	[272]	[246]	[303]
Reusable 20-25°C	37VRCU4V	3.2	4 Day	16.2	7.56	7.19	3.63	12.75	10.75	11.00
				[7.4]	[192]	[183]	[92]	[324]	[273]	[279]

## Envoy & Certis Series Pallet Shippers

**MORE TEMPERATURE OPTIONS. FEWER PACKING COMPONENTS. EASY ASSEMBLY.**

Designed to meet the unique transport requirements of pharmaceuticals, biologics, vaccines, and other high-value life science products.

### Our Polyurethane-insulated pallet shippers feature:

- Refrigerated, frozen, and CRT versions
- Off-the-shelf convenience and fast delivery from stock
- Universal packout - same configuration for all seasons
- Self-supporting panels enable one person assembly in 15 minutes
- Shipped flat to minimize storage space required
- Optimized dimensions for aircraft
- Ideal for pharmaceutical/biologic products, and third party logistics
- Proven temperature assurance



ThermoSafe insulated pallet shippers provide off-the-shelf convenience and reliable temperature assurance for a wide range of products.

Series	Temp.	Duration (hrs)	Packout	Payload Dimensions L x W x H in. [mm.]
Envoy	< -20° C	48	Universal	33 x 24½ x 36½ [838 x 622 x 927]
Envoy	< -15° C	120	Universal	33 x 24½ x 36½ [838 x 622 x 927]
Envoy	2-8° C	96	Universal	22 x 24½ x 36½ [838 x 622 x 927]
Certis	2-8° C	96	Seasonal	33 x 29½ x 22 [838 x 749 x 559]
Certis	2-8° C	120	Seasonal	35 x 29¾ x 9 [889 x 756 x 229]
Certis	2-8° C	120	Seasonal	48 x 40 x 30 [1219 x 1016 x 762]
Envoy	1-10° C	144	Universal	33 x 24½ x 36½ [838 x 622 x 927]
Envoy	15-25° C	72	Universal	33 x 24½ x 36½ [838 x 622 x 927]
Envoy	10-30° C	120	Universal	33 x 24½ x 36½ [838 x 622 x 927]

Universal Design Specs	US Units	Metric Units
External Dimensions	49-1/4 x 40-1/8 x 56-3/8 in	1251 x 1019 x 1432 mm
Internal Dimensions	41-1/4 x 33-3/8 x 50-1/2 in	1047 x 848 x 1280 mm
Payload Dimensions	33 x 24-1/2 x 36-1/2 in	838 x 622 x 927 mm
Payload Capacity	17 ft <sup>3</sup>	484 litres
Weight	670 lbs	304 kgs
Wall Thickness	2-3/4 in	70 mm
Insulation Type	Polyurethane	
Ambient Profile	ISC Silver	

Min. Load: 7 cases, each with 198 x 5mL vials with 5mL water fill  
 Max. Load: 14 cases, each with 198 x 5mL vials with 5mL water fill

# ThermoSafe®

## Medical Transporter

Insulated expanded polypropylene medical transporters are ideal for on-site collection, storage and transport of temperature sensitive specimens, medications, medical devices, and organs.

### BOTH UNITS FEATURE:

- Durable nylon clad transporter with expanded polypropylene container that is stain and impact resistant
- Operating instructions and test data
- Extra space for crushed ice and refrigerant gel packs
- Heavy-duty grip handles for easy lifting
- Side loading clear plastic document holder
- Five disposable 100 µ [4 mil] polyester bags are included—(replacement bags available)
- Conformance with 21 CFR, Part 600.15 (IATA)



*Dolly sold separately*

### Medical Transporter 930

- Qualified by ISC Labs for temporary storage and transport of packed red blood cells with (3) 32 oz [907 g] PolarPack Rigid Bottle refrigerants and (2) 16 oz [454 g] PolarPack refrigerants for operating room storage and blood bank transport
- Maintains up to 8 packed red blood cell units at 1°C-6°C while in storage for 6 hours or more and between 1°C-10°C while in transit for up to 24 hours
- Lightweight, ergonomic design with adjustable and retractable handle and wheels
- Qualification report included

### Medical Transporter 960

- Qualified by ISC Labs for temporary storage and transport of both platelet (20°C-24°C for up to 8 hours) and non-platelet production (1°C-10°C for up to 24 hours) whole blood with crushed wet ice
- Includes operating instructions and test data for cooling platelet and non-platelet production blood
- Qualification report included



**ThermoSafe Medical Transporters** are Ideal for short-term storage, carrying and delivering of temperature-sensitive tissues, serums, vaccines, cultures, specimens, and other temperature-sensitive materials.

- Washable, weather-resistant blue nylon shell with polyethylene foam insulation
- Durable, reusable, and ideal for field samples
- Printed with standard biohazard symbol
- Zipper lock closure



Model	Volume [ft <sup>3</sup> ]	Blood Unit Capacity (with refrigerant)	Wall Thickness [in.]	Dimensions LxWxH		Empty Weight [lb]
				Inside [in.]	Outside [in.]	
931	0.30	N/A	¼	5 x 7¾ x 9¾	11⅞ x 8¾ x 11	2
640	0.30	N/A	¼	9¾ x 7½ x 7½	10½ x 8 x 8	1
641	0.30	N/A	⅜	9¾ x 7½ x 7½	10½ x 8 x 8	1
932	0.47	N/A	⅜	7⅞ x 10¾ x 9¾	14¾ x 11¾ x 11	2
930	0.95	8	1	15¾ x 10¾ x 12¾	17¾ x 12¾ x 13¾	7.1 w/baskets
960	1.60	16	1	15¾ x 10¾ x 22¾	17¾ x 12¾ x 24¾	12.2 w/baskets



**Medical Transporter 641**

- Inner partition divides unit and separates specimens. Features built-in lid compartments for U-tek refrigerant packs.
- Adjustable nylon carrying strap for hand or shoulder carrying.
- Lightweight, easy to carry and transport. Model 641 includes a vial foam insert that holds (24) 5 to 15 ml vials and one Model 418 U-tek® 12 oz [340 g].

**Medical Transporter 931 & 932**

- Includes removable, rigid thermoformed tray— ideal for washing and reusing; prevents leaking inside and out of transport unit; reinforces durability.
- Adjustable, durable carrying strap for shoulder transport. Model 932 also features a comfortable, sturdy hand strap.

# ThermoSafe®

## Storage/TransportChest

### Hard Cased Units

- Deluxe containers provide years of trouble-free service. Ideal for dry ice/wet ice storage, field collection, cryogenic testing, and frozen specimen storage
- Rugged polyethylene interior and exterior casing, and super-efficient, non-deteriorating poly-urethane foam insulation
- Rounded interior corners for easy clean-up
- Detachable lid makes Model 304 perfect for storing dry ice at the bench top



Model	Volume [ft <sup>3</sup> ]	~Dry Ice Capacity [lb]	Average Holding Time <sup>+</sup> [days]	Wall Thickness [in.]	Dimensions L x W x H		Empty Weight [lb]	Hardware	Handling Accessories
					Inner [in.]	Outer [in.]			
<b>Polyethylene casing with urethane foam insulation R-value: 1.1Km<sup>2</sup>/W [6.2 per inch]</b>									
304	0.7	50	7	1¾	115/16 x 10¾ x 10¼	15 x 141/16 x 13½	12	N/A	Optional Carrying strap (Model 385)
422	0.7	50	7	1¾	115/16 x 10¾ x 10¼	15 x 141/16 x 13½	12	Lid hinge w/2 latches; carrying handle	N/A
390	1.0	80	10	2¼	1611/16 x 10¼ x 10¼	215/16 x 147/8 x 13¾	16	Lid hinge w/stay and 2 latches; carrying handle	Optional Stacking basket (Model 388)
<b>Laminated fiberboard with EPS insulation R-value: 0.74 Km<sup>2</sup>/W [4.2 per inch]</b>									
314	0.44	24	1.9	1½	10½ x 7¼ x 10	13¾ x 10½ x 13½	3	N/A	
311	0.60	33	2.6	1½	11¾ x 10 x 8¾	15½ x 13¾ x 12¾	4	N/A	Optional: Carrying strap (Model 385)
327	0.70	39	3.1	1½	11¾ x 8¾ x 11	13¾ x 10½ x 13	5	N/A	
309	1.0	54	5.5	2	12 x 12 x 11½	16 x 16 x 15½	7	N/A	Included: Carrying strap [no handles]
399	1.5	81	6.5	1½	19¾ x 12¾ x 1215/16	22½ x 15¾ x 15¾	6	N/A	Included: Carrying harness, [no handles]
308	1.6	87	7	1½	17 x 9¾ x 16½	20¾ x 13¼ x 9½	6	N/A	Included: Carrying harness with handles

~Weight calculated using pelletized dry ice. + Average time before full sublimation.



## Fiberboard Units

- Mobile storage chests are available in five models with capacities from .44 to 1.6 cu. ft. [12 to 45 liter]
- Lightweight, value-priced low-temperature storage
- 275 lb [124 kg] bursting test laminated fiberboard exterior and EPS foam interior
- Tight-fitting plug lid
- Optional handling accessories available



## Handling Accessories

	Model	Dimensions [in.]	Fits Insulated Chest*
Aluminum Dollies	375	N/A	Models 305
	376	N/A	Models 300, 301
	377R	N/A	Models 302, 303, 306, 307
Carrying Strap	385 (no handles)	N/A	Models 304, 311, 314, 328UPS
Stacking Baskets	378	12¼ x 21 x 4¾	Five nest in Models 300, 301, 305, 424
	379	16 x 16 x 4¾	Three nest in Models 302, 303 Two nest in Models 306, 307

**Carrying Straps** (shown above on Fiberboard units)  
Converts insulated chests into mobile carriers while securing lid during transport. Facilitate easy handling. Manufactured from woven, industrial-grade polypropylene.

**Aluminum Dollies**  
Ease transport and handling. Feature sturdy 4 in. [102 mm] diameter swivel casters with brakes.

**Stacking Baskets**  
Makes it easy to move bottles, bags, vials, and packages from one chest to another. Special overlap feature permits secure stacking. Constructed of white vinyl-coated welded steel wire.

For models not listed on pages 21-22, see [www.thermosafe.com](http://www.thermosafe.com) for additional information.

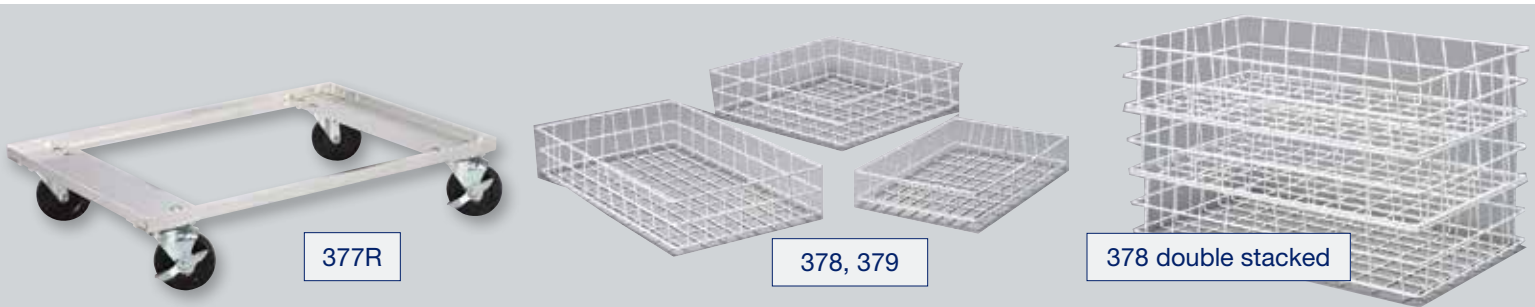

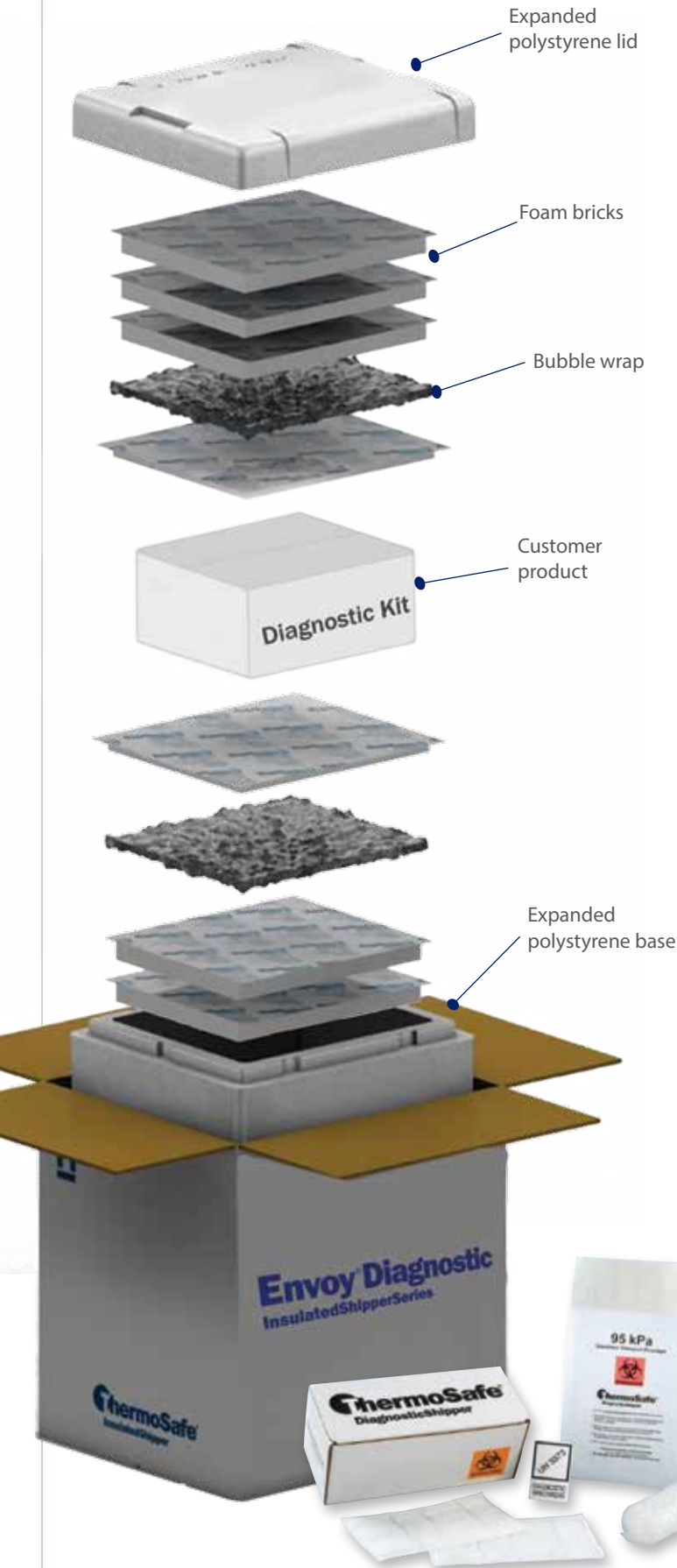

# Envoy<sup>®</sup> Diagnostic InsulatedShipperSeries

A simple, economical solution for refrigerated temperature control of diagnostic kits, blood samples, and other diagnostic specimens

- A convenient all-in-one solution with proven thermal performance
- Ideal for 1 to 2 day shipments and small payloads
- Packouts are simple to follow and incorporate foam bricks for uniform temperature coverage.

Envoy is a simple and economical 2 to 8 °C insulated shipping system that has been design-tested to ISCSilver™ ambient temperature profile to address the need for temperature assurance in moderate shipping conditions.

The table below offers a list of Diagnostic and Infectious Shippers that are offered in both configurations (kits and Envoy shippers).

Envoy Model #	Included Diagnostic Kit	Shipping Duration (Hrs)
Outer Dimensions: 15" x 13½" x 16" [381 x 337 x 406] mm		
Weight: 22 lbs [10kgs]		
ERWS2LE472	472*	54
ERWS2LE473	473*	54
ERWS2LE570	570	54
ERW2SLE600	600	54
ERWS2LEIN2	INF2000	54

\* Vials not included with the ERWS2LE472 and ERWS2LE473 models.

# ThermoSafe®

## DiagnosticShipper

### Diagnostic Specimen Mailing Systems

These ready-to-use combination packaging kits have been tested and certified for the transport of diagnostic specimens as defined by the applicable regulations, in conformance with IATA Packing Instruction 650, U.S. Postal Service and DOT regulations [UN3373].

- Foam shippers and packaging accessories also are available separately for use with customer-furnished primary receptacles.



Model	Holds	Includes	Outer Dimensions LxWxH [in.]	Replacement Parts Foam Mailers ONLY	Accessory Pack
473	3 x 10 ml tubes*	10 ml tubes, EPS mailer and lid, absorbent material, waterproof tape, corrugated shipping carton, press lock poly bag, UN3373 label and instruction sheet	5 5/8 x 4 x 2	Model 476	Model 474T
472	8 x 10 ml tubes*		10 1/2 x 5 5/8 x 3	Model 470	Model 471T

\* Vials not included with the ERWS2LE472 and ERWS2LE473 models.

# ThermoSafe®

## DiagnosticShipper



### Flexible Mailer (without tubes)

570

Complies fully with U.S. Postal Service, DOT and IATA regulations for transport of clinical and diagnostic specimens (UN 3373). Includes all required secondary and outer packaging components.

Accommodates up to 16- 10 ml plastic specimen tubes.

Max capacity is 300 ml.

Model	Corrugated Carton I.D. [in.]	Plastic Envelope [in.]	Absorbent Sheets [in.]	Bubble Wrap	UN3373 Label
570	9½ x 4 x 4	1- printed with international biohazard symbol 6 x 9 ¾ /95 kPa (14 psi)	2 - 7 ½ x 4 ⅝ 240 ml capacity	1- 6 x 24 in.	1
575*	N/A	95 kPa Plastic Bag	4 - 7 ½ x 4 ⅝ 600 ml capacity	25/Case	N/A

\*Accessory Kit for Model 570. All models include one User Instruction Sheet

### Drug Test Kit

600

All-in-one, easy to use drug test mailing system that meets postal and courier service regulations for non-hazardous clinical specimens.

Includes one of each of the following:

- 90 ml Specimen Bottle, Screw Top Cap, & Temperature Indication Label - 13 in. dia x 3 in. [44 mm dia. x 76 mm]
- Pad of Absorbent Material - 4 x 2 ¾ in. [102 x 70 mm]
- Press-Lock Plastic Bag - 5 ⅞ x 9 ⅝ in. [149 x 245 mm]
- EPS Foam, Model 601 (see page 29)
- Corrugate Carton - 7 x 4 ¼ x 3 ⅝ in. [177 x 105 x 92 mm]
- Security Seal - 7 in. L x 1 in. W [178 mm L x 25 mm W]

# ThermoSafe®

## DiagnosticShipper

### 95 kPa Bags

Specimen transport bags are liquid tight and tamper evident.

The patented adhesive closure and continuous seal meet or exceed standards of all major air carriers and DOT.

Polyethylene construction and adhesive closure provides added security during handling by personnel.

Model	Inside Dimensions [in.]	Case Pack
951	6 x 9 <sup>3</sup> / <sub>8</sub>	250
952	9 x 12	250
953	9 x 16	250
954	13 <sup>1</sup> / <sub>4</sub> x 17 <sup>7</sup> / <sub>8</sub>	100
955	10 <sup>1</sup> / <sub>4</sub> x 14	250
*958	13 <sup>1</sup> / <sub>4</sub> x 17 <sup>7</sup> / <sub>8</sub>	100

\* Bag without biohazard logo.



# ThermoSafe®

## InfectiousShipper

Meets U.S. Department of Transportation (DOT) and IATA requirements for transporting infectious substances (UN 2814 and UN 2900).

4 models– accommodate shipments from 4 to 6 tubes/vials.

Pre-assembled packaging includes everything needed for shipping infectious agents in accordance with DOT Regulation 49 CFR Parts 171 to 178 and IATA Packing Instructions 602.



*Note: Compliance with UN/DOT regulations governing shipments of infectious substances in these approved shippers is contingent on the use of all supplied components. The Shipper is ultimately responsible for determining the suitability of packaging for use with contents. Consult appropriate regulations. \**

### Dry Ice Overpack

670

Substance Shippers protect frozen samples for over four days. The EPS foam container and lid accommodate either Model 630 or Model 660B shipper, plus 25 lb [11 kg] of dry ice. Foam insert holds in place while dry ice sublimates. Includes one Class 6 Infectious Substance label and one Class 9 Miscellaneous Dangerous Goods label (for dry ice), and shipping carton.

Model	Vessel/ Dimensions [in.]	Internal Cushioning	Capacity	Outer Dimensions LxWxH [in.]	Supplied Labeling	Additional Features
630	Aluminum can 3 x 6	Foam insert	Four 16 x 100 mm tubes	5 ½ x 5 ½ x 11 ¼	Infectious substance	Includes 4 x 10 ml blood collection tubes
660B		Absorbent material, flexible pressure vessel & bubble wrap material	Six 16 x 100 mm tubes maximum volume 60 ml	5 ½ x 5 ½ x 11 ¼	Infectious substance	Flexible pressure vessel accepts various sized tubes
670	N/A	EPS Insulated Shipper	Overpack for Models 630 and 660B	14 x 14 x 14 ⅝	Infectious substance & miscellaneous dangerous goods	Foam insert holds up to 11.3 kg [25 lb] of dry ice in place
INF2000	0.5 liter transparent container	Compartmentalized bubble pouch	Six tubes	4 x 4 x 6 ¾	Infectious substance & diagnostic	Liquid-tight container withstands up to 95kPa pressure
INF3000	1.0 liter transparent container	Compartmentalized bubble pouch	Up to 50 ml	6 ¼ x 6 ¼ x 7 ½	Infectious substance	Liquid-tight container withstands up to 95kPa pressure; vessel is autoclavable for re-use





**Infectious Shipper** 630

ThermoSafe shippers include EPS foam container, flexible foam insert, clear plastic press-lock bag, secondary packaging and absorbent material for full capacity of blood, corrugated carton, and step-by-step packing instructions.



**Infectious Shipper** INF3000

Infectious shippers include pressure vessel with stop-lock lid, compartmentalized bubble pouch, 50 ml absorbent sheet, corrugated outer carton with required markings, shipper's declarations, and easy-to-follow instructions.

# ThermoSafe® LabMailer

## Vial Shippers

This unique array of shipping systems protects frozen and refrigerated shipping vials. These ready-to-use kits include everything to keep sensitive goods in top condition. Just load your product, add a U-tek® phase change material pack, and close the shipper.

- Shippers (Models 480-413 and 480-490) also include U-tek and reusable polyethylene platform
- This series of Shippers (Models 413-C24 and 490-C24) also include flexible polyurethane foam cushion



Model	Holds	Includes	Dimensions	
			Inner LxWxH [in.]	Outer LxWxH [in.]
480-413	(12) 28 ml vials	EPS container and lid, 24 oz [680 g] U-tek phase change material, reusable polyethylene platform and corrugated shipping carton	8 x 6 x 7	11 x 9 x 10
480-490	(48) 28 ml vials		12 x 10¼ x 5½	14 7/8 x 13¼ x 8¼
413-C24	(24) 16-20 ml vials	EPS container and lid, corrugated shipping carton and 24-hole flexible foam insert	8 x 6 x 7	11 x 9 x 10
490-C24	(48) 16-20 ml vials		12 x 10¼ x 5½	14 7/8 x 13¼ x 8¼



# ThermoSafe®

## LabMailer

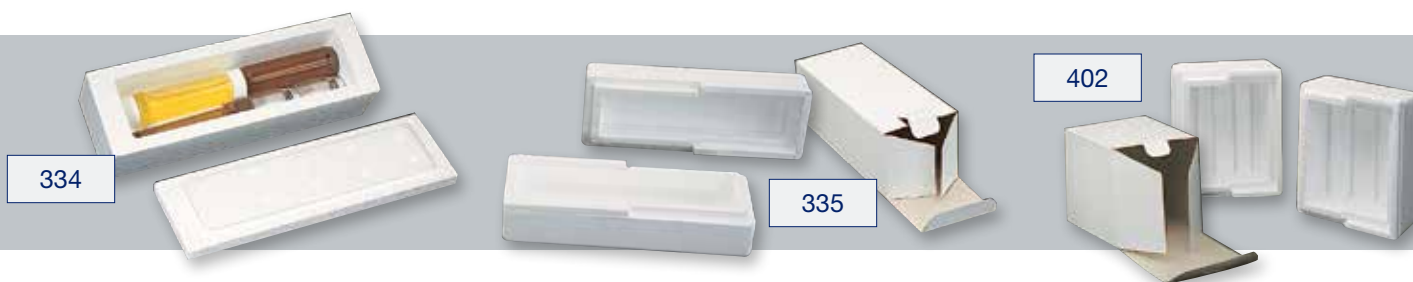

Model	Holds	Cavity Dimensions [in.]	Outside Dimensions L x W x H [in.]	Recommended Mailing Sleeve
334	Cans, screw-cap vials, tubes, swabs, air filter cartridges	8 x 2 ¼ x 1 ½	9 ½ x 3 x 2 ¾	392
335	Specimen tubes, vials, swabs	5 7/8 x 1 ½ x 1 ½	7 x 2 ½ x 2 ½	336
402	Tubes, vials, cans, bottles. Can be used with Poly-Pad foam cushion to keep containers from shifting	4 x 3 ½ x 3 ¼	5 ¼ x 4 ¾ x 4 ¾	372
400	1 or 2 standard petri dishes	4 x 1 ½ x 4	5 ¼ x 5 x 2 ½	N/A
404	10 standard petri dishes	6 ¼ x 3 ¾ x 4	7 ½ x 4 7/8 x 5	403
601	Bottles, cans, vials, cups. Can be fitted with foam insert to hold small kit components	6 x 3 x 2 ½	7 x 4 x 3 ½	602
605	100ml sample containers, 4 oz [113 g] urine cup	3 ¾ x 2 ¼ x 1 ½	4 ¾ x 3 ¾ x 3 ¼	606
440	Vials, tubes, small bottles, tissue flasks with growth area of 75 cm <sup>2</sup> . Can be used with Model 441 [flexible foam pad]	5 7/8 x 4 3/8 x 3	8 x 6 ½ x 5 1/8	442, 440KD
395	2 oz [57 g] bottle or Model 435 aluminum can	3 ¼ x 2 dia.	4 3/8 x 3 ¼ x 3 ¼	396
312	Tubes, vials, ampules	4 ¼ x 6 ¾ dia.	10 x 10 x 7 ½	Corrugated carton included



Model	Holds Tube/Slide Specifications				Outside Dimensions L x W x H [in.]	Tube Cavity Dimensions [mm]	Recommended Mailing Sleeve
	Tubes	Slides	Tube Vol. [ml]	Tube Dimensions [mm]			
356	1	N/A	3, 5, 7, 10	Dia.: 10.25 to 16 Length: 75 to 103	5 ¾ x 2 ¼ x 2	110 x 16	357
362	2	2	5, 7, 10	Dia.: 10.25 to 16 Length: 75 to 103	5 ½ x 3 ½ x 1 ¾	107 x 16	363
364	3	N/A	3, 5, 7, 10	Dia.: 10.25 to 16 Length: 75 to 103	5 ⅝ x 4 ½ x 1 ¼	105 x 17	365
407	4	8	7, 10	Dia.: 16 Length: 75 to 100	6 ⅜ x 5 ½ x 1 ¾	110 x 19	408
339	5	N/A	3, 5	Dia.: 10.25 to 13 Length: 75 to 103	5 ⅝ x 4 ½ x 1 ½	105 x 13	365 & 340
409	5	N/A	7, 10, 15, 25	Dia.: 16 Length: 75 to 150	7 ⅞ x 5 ¼ x 1 ½	170 x 16	410
341	8	8	5, 7, 10	Dia.: 10.25 to 16 Length: 75 to 103	10 x 5 ½ x 1 ¾	113 x 18	342
369	N/A	10	N/A	N/A	4 x 2 ½ x 2	N/A	370



### Aluminum Cans

Accommodate most widely used laboratory collection tubes, vials, and bottles. Help prevent breakage during handling and shipment. Seamless construction with lined screw-caps to prevent leakage. Completely autoclavable. EPS foam mailers and mailing sleeves available.

Model	Dimensions [in.]		Recommended EPS Mailer
	Can	Outer [L x W x H]	
435	1 ¾ dia. x 4 ¾	2 dia. x 4 7/8	373
436	2 ½ dia. x 6	2 5/8 dia. x 6	353



# ThermoSafe®

## LabMailer

Maximum breakage protection for known non-hazardous blood, serum, tissue, and other specimens. Accommodates VacuTainer®, Microtainer®, and other collection/transport tubes\*.

Available in multi-tube, slide, and tube/slide combinations. Lightweight, reusable and recyclable.

\*Trademarks of Becton Dickinson



### Histopathology Mailer

394

This versatile combination mailer carries 10 vials, 2 slide packets, or 5 vials, and 1 slide packet. Cavities measure 105 mm long x 13 mm in dia. Suitable for use with Model 365 mailing sleeve.

### Mailing Sleeves

Sturdy 18-point white paperboard sleeves increase the cost-effectiveness of foam mailers. Reverse tuck closures enable foam mailers to withstand multiple trips. Sleeves 340 & 342 are printed.



Model	Fits Foam Mailer	L x W x H [in.]	Sleeves Per Case
357	356	6 x 2 <sup>3</sup> / <sub>8</sub> x 2 <sup>1</sup> / <sub>8</sub>	300
363	362	5 <sup>5</sup> / <sub>8</sub> x 3 <sup>1</sup> / <sub>2</sub> x 1 <sup>7</sup> / <sub>8</sub>	300
340/365	364, 339, 394	5 <sup>3</sup> / <sub>8</sub> x 4 <sup>5</sup> / <sub>8</sub> x 1 <sup>5</sup> / <sub>8</sub>	300
408	407	6 <sup>5</sup> / <sub>8</sub> x 5 <sup>5</sup> / <sub>8</sub> x 1 <sup>7</sup> / <sub>8</sub>	200
410	409	8 <sup>1</sup> / <sub>8</sub> x 4 <sup>3</sup> / <sub>4</sub> x 1 <sup>5</sup> / <sub>8</sub>	200
342	341	10 <sup>1</sup> / <sub>4</sub> x 8 <sup>3</sup> / <sub>4</sub> x 1 <sup>7</sup> / <sub>8</sub>	200
370	369	4 x 2 <sup>5</sup> / <sub>8</sub> x 2 <sup>1</sup> / <sub>4</sub>	300

See pages 28-30 for information about Foam Mailers.



More information and Specs on page 8

### E38 PLATE- PUR Shipper

E38 PLATE

Shown (above) packed with platelets. This shipper has been pre-qualified for room temperature shipments of blood platelets 24 hrs. Qualification report is included with product.

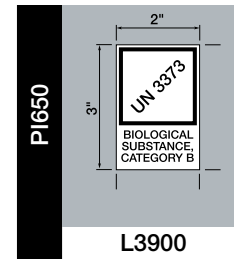

### IATA Hazard Label

LS900

High quality labels are easy-to-read identification for hazardous loads. 3 x 4 in. [75 x 50 mm]

500/roll



Shown with optional 8 oz [230 g] U-tek and optional 441 flexible foam pad.

**Mini Mailer/U-tek® Economy Packs 443, 444**

**Model 443 Economy Pack**

Includes:

24 – Model 440 Mini Mailers

36 – Model 432 U-tek refrigerant packs -23 °C (-10 °F)

**Model 444 Economy Pack**

Includes:

24 – Model 440 Mini Mailers

36 – Model 429 U-tek refrigerant packs -1 °C (+30 °F)

## Mini Mailers – for temperature-sensitive shipments

- Compact protection for temperature-sensitive shipments... ideal for serums, tissues, and reagents
- Accommodate tubes, vials, ampules, small bottles, and tissue flasks with space for refrigerants
- Insulating, thick-wall polystyrene foam construction
- Walls on Model 440 are 1 in. [25 mm] thick; walls on Model 312 are 1 ½ in. [38 mm] thick
- Maximum breakage protection for non-hazardous laboratory specimens... ideal for biological, environmental, research and development, public health, industrial hygiene, and veterinary use
- Accommodate tubes, vials, bottles, petri dishes, and cans
- Lightweight polystyrene foam construction saves postage
- Reusable and recyclable
- Standard mailing sleeves available



See page 12 for more information on U-tek refrigerant packs.

# ThermoSafe® PackagingMaterial

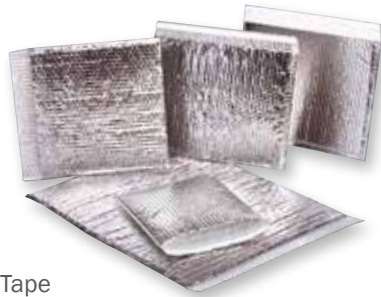

Metallized Bubble Pouch with Self Sealing Lip and Tape

Lightweight and easy to use. Saves inventory space. Constructed of 3/16 in. [9 mm] metallized bubble with 2 in. [51 mm] lip and tape.

Model	Dimensions [in.]	Case Pack
MP811	8 x 11	350
MP1211	12 x 11	250
MP1217	12 x 17	200
MP1223	12 x 23	150
MP1823	18 x 23	100



Absorbent Sheets designed to absorb and encapsulate spills in accordance with UN/DOT regulations, U.S. Postal Service and recommendations for the packaging and transportation of diagnostic specimens, biological materials, and other dangerous goods. Tissue-based paper substrate constructed with super-absorbent polymers help prevent leakage, and possible contamination.

Model	Dimensions [in.]	Sheet Capacity	Case Pack
ZORB33	3 x 3	90 ml of water 22.5 ml blood	10,000
ZORB66	6 x 6	360 ml of water 90 ml blood	500
ZORB1212	12 x 12	1440 ml of water 360 ml blood	500

# ThermoSafe® LabWare

ThermoSafe® Lab Ware shippers are versatile insulated shippers that aid temperature-sensitive enzymes and reagents at workstations. Durable components are designed for convenience while in transit or in-use. These shippers are lightweight and easy to handle.



## Low Temp Chiller 423

Economical cold trap or alcohol/dry ice bath. Convenient shallow depth has 1½ in. [38 mm] insulating walls.

Holds; wet or dry ice, alcohol

Measures:

ID - 19 3/8 x 11 1/4 x 3 7/8 in. [564 x 286 x 98 mm]

OD - 22 5/8 x 14 7/8 x 7 1/4 in. [575 x 378 x 184 mm]

## Tube Rack/Shipper 416, 419

This dual purpose shipper holds 48 tubes of various diameters and lengths.

Measures:

13 x 5 x 3 3/8 in. [330 x 127 x 86 mm]

Adjustable height corrugated shipping carton, Model 419 is available separately,

Measures:

14 x 5 x 7 3/8 in. [356 x 127 x 187 mm]

## Labtop Cooler 650

Protects temperature sensitive enzymes and reagents. Maintains product between -18°C and -16°C (0°F and 2°F) for up to 10 hours. Includes two sets of cold cells -U-tek® phase change materials packs.

Holds: 15 x 0.5 ml and 15 x 1.5 ml tubes

Measures:

9 x 6 1/2 x 6 in. [229 x 165 x 152 mm]



# ISCLabs®

## *Design & Testing Services*

### **The ISC Labs Difference:**

ISC Labs has a specialized focus on engineering and testing services to provide optimized temperature assurance packaging solutions for each customer's specific needs.

Industry-leading thermal modeling capabilities enable rapid development of highly optimized custom solutions. Multiple design alternatives are presented to allow each customer the ability to easily analyze their options. Materials including EPS, PUR, VIP, and phase change materials are prototyped as necessary.

Thermal testing is accompanied by distribution testing to prove each temperature assurance packaging solution not only maintains temperature control, but also withstands the rigors of distribution.

Laboratory and engineering staff work with clients throughout all phases of the packaging development and testing process. Engineering professionals review test progress, develop modifications, and recommend alternative approaches to ensure the client's valuable products maintain their temperature requirements during each stage of the "cold chain."



**For more information on ISC Labs® thermal package design, testing, and qualification services, visit our website or call our customer service department at +1 800 225 7443**



Sonoco ThermoSafe  
(Corporate Headquarters)  
3930 North Ventura Drive, Suite 450  
Arlington Heights, Illinois 60004  
USA  
Tel: +1 800 225 7443  
Fax: +1 847 398 0653

ThermoSafe Brands Europe Ltd  
Quartertown Industrial Estate  
Mallow, Co. Cork  
Ireland  
Tel: +353 22 55112  
Fax: +353 22 55114

[www.thermosafe.com](http://www.thermosafe.com)